

# MK-101 TILE SAW OWNERS MANUAL, PARTS LIST & OPERATING INSTRUCTIONS

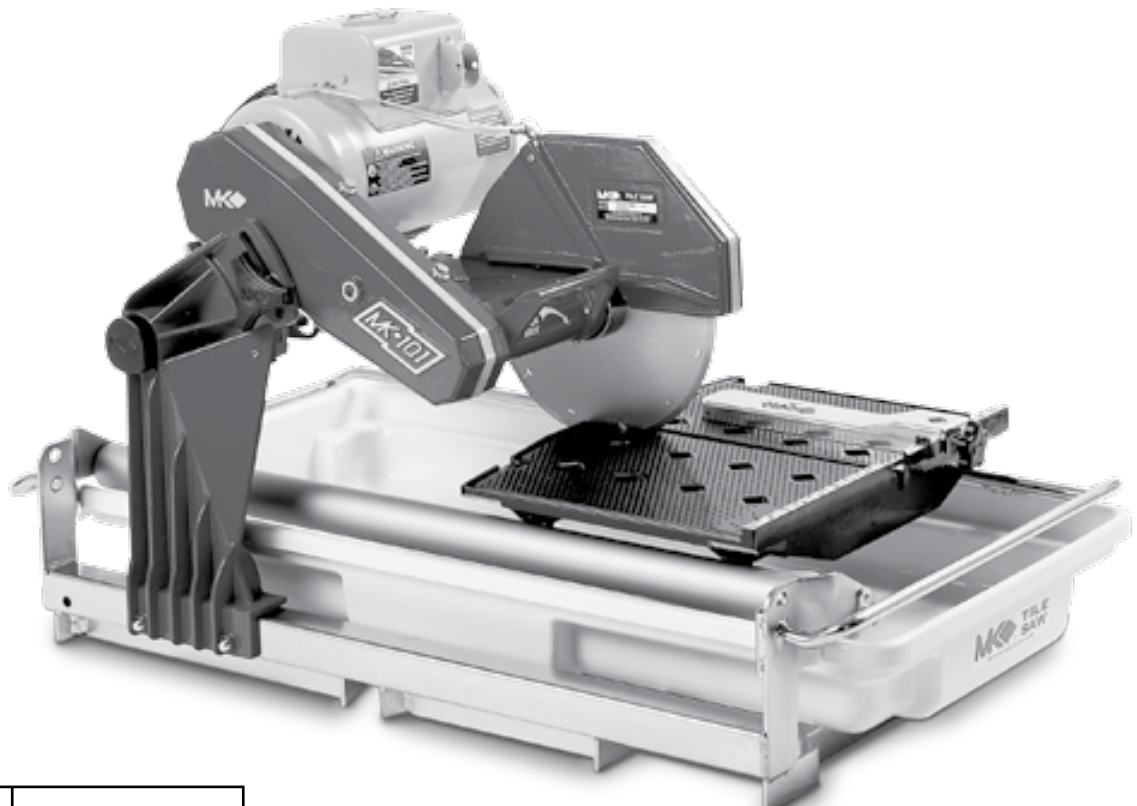

Revision 101	04.2011
Manual Part# 153754	

**Caution:** Read all safety and operating instructions before using this equipment. This owner's manual **MUST** accompany the equipment at all times.



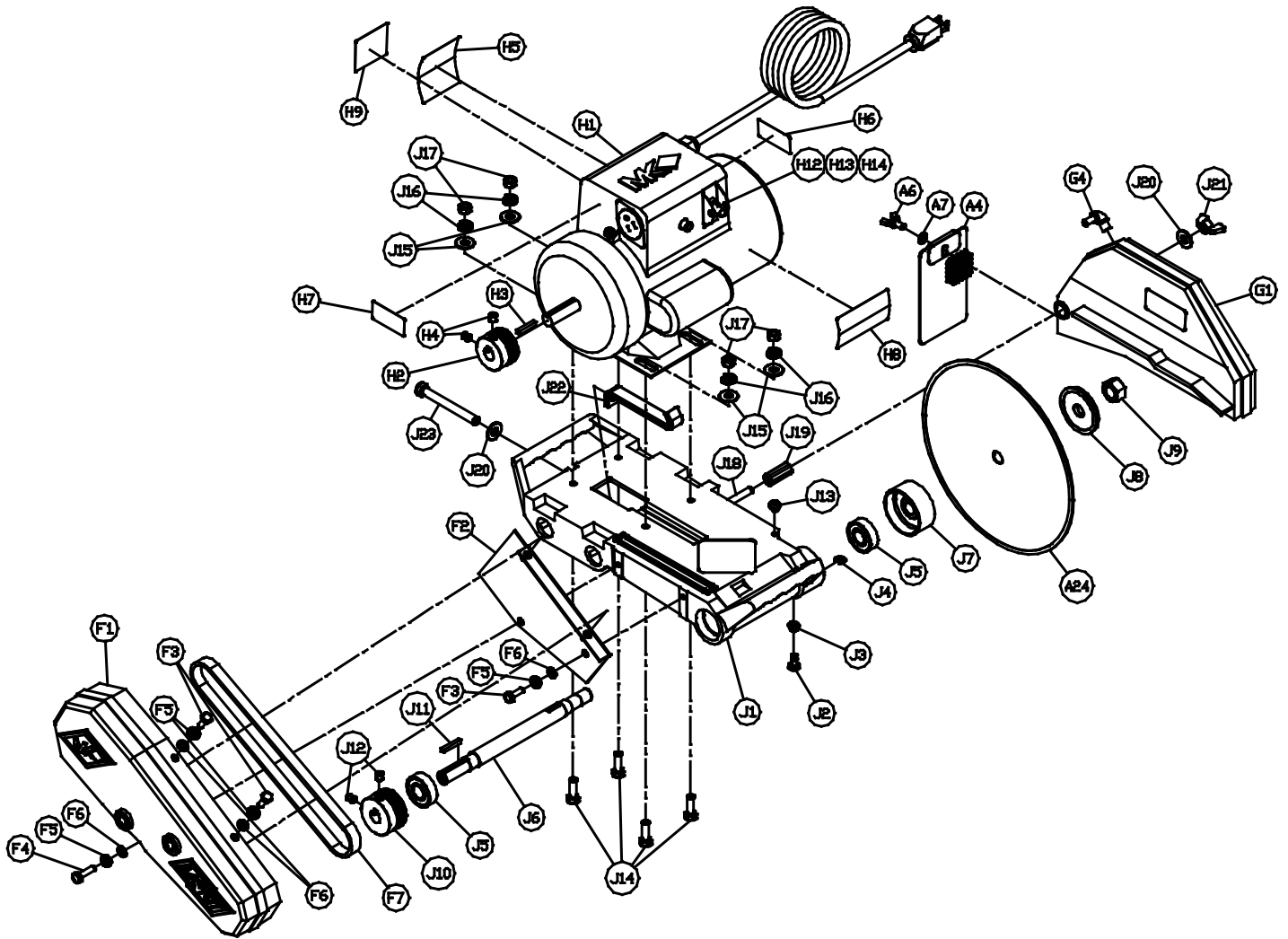

ITEM	DESCRIPTION	QTY	PART #
A	ACCESSORIES	-	-
A1	CARTON, ACCESSORY PACK, 101	1	153366
A2	FOAM, ACCESSORY PACK CARTON	1	154022
A3	WRENCH, 15/16 CLOSED END	1	134684
A4	GUARD, SPLASH	1	160310
A6	WINGSCREW, 1/4-20 X 1/2	1	151888
A7	WASHER, 1/4 SAE FLAT	1	151915
A8	PUMP, WATER, G-150A	1	151271
A9	FITTING, PLASTIC, 1/4 FNPT X 1/4 BARB	1	128397
A10	HOSE, VINYL, 1/4 ID	6'	132951
A11	CLAMP, FLOW, 1/4-1/2	1	154394
A13	RIP GUIDE, LARGE DIE CAST (COMP)	1	159751
A14	MITER, LARGE BULLNOSE (COMP)	1	153201
A15	GUIDE, DUAL FLAT 45 (COMP)	1	134577
A16	PROTRACTOR, TILE SAW	1	159429
A17	DRESSING STICK, 8 X 2 X 1, 60 GRIT	1	152792-RW
A18	EXTENSION, 2.25 X 3/4 DIA. BELT GUARD	1	155711
A19	CORD, TWIST-LOCK GFCI, 120V/15A	1	157421
A20	OWNER'S MANUAL, MK-101	1	153754
A21	CARD, MK WARRANTY REGISTRATION	1	155037
A22	LABEL, DO NOT RETURN	1	157063
A23	SELL SHEET, TILE ACCESSORY	1	156915
A24	STAND, FOLDING, UNIVERSAL, W/CARTON (156035)	1	151889
A25	BLADE, MK-100, 10 X 060 X 5/8	1	154380
A26E	TAG, SERIAL NUMBER, BLANK	1	157500
A27	PLUG, 10A AUSTRALIA	1	156267
A28	CORD, L5-15X25' EXTENSION	1	158111
A29	MITER, SMALL BULLNOSE (COMP)	1	134585
A30	CLIP, TABLE LOCK, 30 DEG	1	160331-1
A31	CLIP, TABLE LOCK, 50 DEG	1	160331-3
A32	DRIVE SCREW, ROUND HEAD, #7 X 5/16	2	157849
A33	HOLDER, TOOL ACCESSORY	1	160155
A34	LID, ACC HOLDER DRESSING STICK-CLEAR	1	160156
A35	LID, ACC HOLDER MANUAL-CLEAR	1	150512
A36	CLAMP, HOLDING, PUMP	1	162054
A37	SCREW, WING, 1/4-20X1/2	2	151888
A38	NUT, HEX, 1/4X20	2	151893
C	FRAMES	-	-
C1	FRAME, 101	1	153003

ITEM	DESCRIPTION	QTY	PART #
C2	PAN, PLASTIC, 101	1	150634
C3	PIN, 3/16 X 3/8 ROLL	2	151783
C4	PLATE, ADJUSTMENT	2	151758
C5	PLUG, RUBBER DRAIN	1	153439
C7	DRAIN PLUG, HD RENTAL	1	159529
C8	STRAP, 9" DRAIN PLUG	1	159530
<b>D</b>	<b>POSTS</b>	-	-
D1	POST, 101 MK RED (COMP)	1	155670
D2	SHAFT, 10.63" PIVOT, 101	1	153254
D2A	SHAFT, 12.88" PIVOT, 101PRO	1	155530
D3	SCREW, 3/8-16 X 1/2 SOCKET HEAD SET	1	153710
D4	PLATE, SUPPORT	1	155671
D5	SCREW, 3/8-16 X 2 1/2 HEX HEAD CAP	2	156030
D6	WASHER, 3/8 SPLIT LOCK	2	150925
D7	KNOB, 3/8-16 X 1.5 MK ADJUSTMENT	1	156770-02
D8	WASHER, 3/8 SAE FLAT	1	150923
D9	PLASTIC POST COVER	1	160157
<b>E</b>	<b>STOP, CUTTING HEAD</b>	-	-
-	KIT, STOP, 10" CUTTING HEAD	1	157728-MK
E1	STOP, 10" CUTTING HEAD	1	157728
E2	SCREW, 1/4-20 X 1 1/4 HEX HEAD CAP	1	157145
E3	WASHER, 1/4 SPLIT LOCK	1	152591
E4	SHEET, CUTTING HEAD STOP INSTRUCTION	1	157728-IS
<b>F-J</b>	<b>CUTTING HEAD ASSEMBLIES</b>	-	-
-	ASSEMBLY, DC CUTTING HEAD, MK-101	1	158478
	<b>BELT GUARDS</b>	-	-
F1	BELT GUARD, MK-101 (COMP)	1	158319-01
F2	BRACKET, INNER BELT GUARD, 100/101	1	158611
F3	SCREW, 1/4-20 X 3/4 HEX HEAD CAP	3	152370
F4	SCREW, 1/4-20 X 1 HEX HEAD CAP	1	152676
F5	WASHER, 1/4 SPLIT LOCK	4	152591
F6	WASHER, 1/4 SAE FLAT	4	151915
F7	BELT, 260J6 MICRO-V	1	158194
<b>G</b>	<b>BLADE GUARD ASSEMBLY</b>		
-	ASSEMBLY, BLADE GUARD, MK-101	1	152582
G1	BLADE GUARD, 101/115 (COMP)	1	153659
G2	TUBE, WATER	2	155389
G3	SCREW, 5/16-18 X 1/2 SOCKET HEAD SET	3	152607
G4	ELBOW, 1/8 MNPT X 1/4 BARB 90° BRASS	1	154652
<b>H</b>	<b>MOTORS</b>		
	ASSEMBLY, MOTOR, 1-1/2HP\120V\60HZ\30A SBOX	1	159709
H1	MOTOR, 1-1/2HP\120V\60HZ	1	160127

ITEM	DESCRIPTION	QTY	PART #
H2	PULLEY, 6J17 X 5/8 BORE	1	158214
H3	KEY, 3/16 X 3/16 X 1-1/8 SQUARE	1	150344
H4	SCREW, 5/16-18 X 3/8 SOCKET HEAD SET, CUP POINT	2	157083
H5	LABEL, WARNING MOST MOTOR..., 2 3/4 X 2 7/16	1	155672
H6	LABEL, CAUTION, GFCI, 1 X 2 1/8	1	155678
H7	LABEL, CAUTION, 5 AMP MAX., 1 X 2-1/8	1	154822
H8	LABEL, WARNING, READ OWNER'S MANUAL, 1-3/4 X 3-3/8	1	155806
H9	LABEL, MK SERVICE INFO., 2 1/8 X 1-13/16	1	155038
H10	LABEL, MK CHECKLIST	1	157459
H11	SCREW, 1/4-20 X 1 HEX HEAD CAP	2	152676
H18	BOX, TOP ENTRY, 30A SWITCH (COMP)	1	159487
H19	COVER, 30A SWITCH BOX (COMP)	1	159539
H20	LEVER, ACTUATOR, 30A SWITCH BOX (COMP)	1	159540
H21	PLATE, MOUNTING, 30A SWITCH	2	159489
H22	LEVER, ON/OFF, 30A SWITCH BOX	1	159490
H23	BUSHING, NYLON, 30A SWITCH BOX	1	158799
H24	SEAL, URETHANE, 30A SWITCH BOX	1	159492
H25	GASKET, 30A SWITCH BOX	1	159491
H26	SWITCH, 30A/2HP/120V/DPST	1	159488
H27	CONNECTOR, LTF11 CORD	1	159582
H28	SCREW, 6-32 X 5/16 FLAT HEAD PHILLIPS MACHINE	6	159493
H29	SCREW, 10-24 X 1/4 PAN HEAD PHILLIPS MACHINE	1	159494
H30	SCREW, 6-32 X 5/8 PAN HEAD PHILLIPS MACHINE	4	157393
H31	SCREW, 10-24 X 5/16 SLOTTED HEX WASHER HEAD GROUNDING	1	159597
H32	WASHER, #10 SAE FLAT	1	154369
H33	WASHER, #10 LOCK, INTERNAL TEETH	2	158336
H34	TERMINAL, 16-14 X #10 RING, NON-INSULATED	1	154540
H35	RECEPTACLE, PUMP	1	159828
H36	CORD, POWER	1	159829
H37	WIRE, MK-100/101 JUMPER	2	160519
H38	LABEL, HOME DEPOT TOOL RENTAL	1	160602
<b>J</b>	<b>CUTTING HEAD SUBASSEMBLIES</b>		
-	SUB-ASSEMBLY, DC CUTTING HEAD, 100/101	1	158191
J1	CUTTING HEAD, DC, 100/101, MK RED (COMP)	1	158224
J2	PIN, BLADE SHAFT LOCK	1	158200
J3	SPRING, BLADE GUARD LOCK	1	158201
J4	E-RING, 1/4 RETAINING	1	158202
J5	BEARING, 17MM X 40MM X 12MM BALL (6203-2NSE)	2	137711
J6	SHAFT, BLADE 100/101	1	158222
J7	FLANGE, 2-3/8 INNER	1	137737
J8	FLANGE, 2-3/8 OUTER	1	135830
J9	NUT, 5/8-18 HEX	1	135848
J10	PULLEY, 6J19 X 5/8 BORE	1	158199

ITEM	DESCRIPTION	QTY	PART #
J11	KEY, 3/16 X 3/16 X 1 1/8 SQUARE	1	150344
J12	SCREW, 5/16-18 X 3/8 SOCKET HEAD SET, CUP POINT	2	157083
J13	BUMPER, 1/2 DIA RUBBER	1	152674
J14	SCREW, 5/16-18 X 1 HEX HEAD CAP	4	151743
J15	WASHER, 5/16 SAE FLAT	4	151754
J16	WASHER, 5/16 SPLIT LOCK	4	151747
J17	NUT, 5/16-18 HEX	4	101196
J18	SCREW, 5/16-18 X 3 HEX HEAD TAP	1	162473
J19	PIVOT, BLADE GUARD	1	153208
J20	WASHER, 3/8 SAE FLAT	2	150923
J21	WING NUT, 5/16-18 NYLOCK	1	151746
J22	STRAP, MOTOR ADJUSTMENT	1	152673
J23	SCREW, 3/8-16 X 3 1/2 HEX HEAD FULL THREAD	1	153147
-	ASSEMBLY, DC TABLE, MK-101	1	158477
<b>K</b>	<b>GUIDE BARS</b>	-	-
K1	BAR, 3/4 X 32 GUIDE, 101	1	134759
K2	COVER, GUIDE BAR, 120° X 35"	1	158403
K3	SPACER, GUIDE BAR COVER, 101	2	152393
K4	SCREW, 5/16-18 X 1 HEX HEAD CAP	2	151743
K5	WASHER, 5/16 SPLIT LOCK	2	151747
K6	WASHER, 5/16 SAE FLAT	2	151754
<b>L</b>	<b>LINEAR BEARINGS</b>	-	-
L1	LINEAR BEARING, 101 (COMP)	1	135855
L2	SCREW, 5/16-18 X 1 HEX HEAD CAP	2	151743
L3	WASHER, 5/16 SPLIT LOCK	2	151747
L4	WASHER, 5/16 SAE FLAT	2	151754
<b>M</b>	<b>TABLES</b>	-	-
M1	TABLE, 100/101 (COMP)	1	157660
M2	TABLE EXTENSION, 101PRO (COMP)	1	154499
M3	SCREW, 1/4-20 X 5/16 SOCKET HEAD SET	2	154226
M4	SHIM, .004 X 5/16 ID X 1/2 OD	4	152519
M5	WASHER, 5/16 SAE FLAT	2	151754
M6	WASHER, 5/16 SPLIT LOCK	2	151747
M7	SCREW, 5/16-18 X 1 HEX HEAD CAP	2	151743
M8	TABLE EXTENSION, FRONT (COMP)	1	158215
M9	SCREW, 1/4-20 X 5/16 SOCKET HEAD SET	2	154226
<b>N</b>	<b>DUAL ROLLER WHEEL</b>		
-	ASSEMBLY, DUAL ROLLER WHEEL	1	159549
N1	BRACKET, ROLLER WHEEL	1	154021
N2	WHEEL, ROLLER	1	151799
N3	SCREW, 1/4-20 X 1 1/2 HEX HEAD CAP	1	151914
N4	WASHER, 1/4 SAE FLAT	1	151915
N5	NUT, 1/4-20 HEX	1	151893

## **THEORY OF DIAMOND BLADES:**

Diamond blades do not really cut; they grind the material through friction. Diamond crystals, often visible at the leading edge and sides of the rim/segment, remove material by scratching out particles of hard, dense materials, or by knocking out larger particles of loosely bonded abrasive material. This process eventually cracks or fractures the diamond particle, breaking it down into smaller pieces. As a result, a diamond blade for cutting soft, abrasive material must have a hard metal matrix composition to resist this erosion long enough for the exposed diamonds to be properly utilized. Conversely, a blade for cutting a hard, non-abrasive material must have a soft bond to ensure that it will erode and expose the diamonds embedded in the matrix. These simple principles are the foundation of “controlled bond erosion”.



### **Types of Cutting:**









There are two basic types of cutting-Dry or Wet. The choice of which type of blade to use depends on

- The requirements of the job
- The machine/tool utilizing the diamond blade
- The preference of the operator

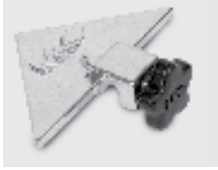
In the case of DRY cutting, the overwhelming popularity and quantity of hand-held saws and the flexible nature of MK Diamond blades to professionally handle most ceramic, masonry, stone and concrete materials, make the DRY cutting blade a very attractive tool. When using a DRY blade, the user must be aware of distinct operating practices to ensure optimum performance. DRY cutting blades require sufficient airflow about the blade to prevent overheating of the steel core. This is best accomplished by shallow, intermittent cuts of the material with periods of “free-spinning” (for several seconds) between each cut, to maximize the cooling process.

For WET cutting applications, MK has the exact blade to compliment both the material to be cut and the wet cutting machine to be used. During cutting operations, liberal amounts of water act as a coolant to support the cutting effectiveness and longevity of the WET blade. Additionally, using water adds to the overall safety of cutting operations by keeping the dust signature down.

Know All You Can About the Material You Wish to Cut

ACCESSORIES:			
ITEM	NUMBER	DESCRIPTION	
1.	137166	MK-200. 10 X 5/8 ARBOR Premium grade Diamond Blade for smooth, chip-free cutting on tile.	
2.	128074	MK-215, 10 X 5/8 ARBOR Supreme grade diamond blade for hard materials	
3.	153252	MK-315, 10 X 5/8 ARBOR Supreme super hi-rim diamond blade	
4.	134577-MK	DUAL 45° FLAT ANGLE GUIDE	
5.	153201-MK	45° Miter	
6.	134569-MK	90° PROTRACTOR	
7.	152792	DRESSING STONE	
8.	152610	GROUND FAULT CIRCUIT INTERRUPTER	
9.	151889	UNIVERSAL STAND	

**ORDERING INFORMATION:**

---

You may order MK Diamond products through your local MK Diamond distributor or, you may order direct from MK Diamond.

**NOTE:** There is a \$25.00 minimum order when ordering direct from MK Diamond. All purchases must be made using VISA or MasterCard.

When ordering direct from MK Diamond, please have the following information ready before calling:

- The Model Number of the saw
- The Serial Number of the saw
- Where the saw was purchased and when
- The Part Number for the part(s) being ordered
- The Part Description for the part(s) being ordered

All parts may be ordered by calling toll free to – 800 421-5830 or 310 539-5221 and asking for Customer Service. For technical questions, call – 800 474-5594.

**RETURN MATERIALS POLICY:**

---

To expedite the service relative to the return of a product purchased through MK Diamond, please observe the following:

**NOTE:** When returning all items, they must have been purchased within the previous twelve (12) months.

- Have the Model Number of the saw
- Have the Serial Number of the saw
- Have the location of where the saw was purchased
- Have the date when the saw was purchased
- Contact Customer Service for approval to return the item(s)
- Obtain a Returned Goods Number (RGA) authorizing the return
- Follow the packaging instructions in the following section
- Ensure your item(s) are prepaid to the destination

For returned items, call toll free to – 800 421-5830 or 310 539-5221 and ask for Customer Service. For technical questions, call – 800 474-5594 or 310 257-2845.

**PACKAGING INSTRUCTIONS:**

---

- Remove the Blade guard and Support Angle Assembly
- Dry the saw before shipping
- When packing, include the following: MK-101, Diamond Blade, Blade guard and Support Angle Assembly and Adjustable Cutting Guide (Other Accessories are not required)
- Package the unit in its original container or one of comparable size (do not ship the unit partially exposed)
- Ensure all parts are secured in the packaging to prevent moving

**AUTHORIZED SERVICE CENTERS:**

---

For quicker repair time, you may contact MK Diamond Customer Service, toll free, at – **800 421-5830** or **310 539-5221** for the Authorized Service Center closest to you. For technical questions, call – **800 474-5594**.

**MK-101 Tile Saw**  
**OWNERS MANUAL & OPERATING INSTRUCTION**  
**DOCUMENT NO. 153754**



**MK Diamond Products, Inc.**

MK Diamond Products, Inc.  
1315 Storm Parkway  
Torrance, CA 90501

Toll-Free: (800) 845-3729  
Phone: (310) 539-2221  
Fax: (310) 539-5158  
[www.mkdiamond.com](http://www.mkdiamond.com)